



ABOUT THIS MANUAL AND MT XPRESS

Thank you for purchasing an **MT Xpress** product.

All of our equipment is assembled and packed with great care. If you should find any incorrect item, please contact your **Xpress** Dealer immediately.

MT Xpress products are Weights & Measures approved precision weighing instruments. However, you may want to obtain official certification through your supplier or local Weights & Measures office.

This **MT Xpress** product was developed, produced, and tested in a METTLER TOLEDO facility that has been audited and registered according to international ISO 9001 quality standards and ISO 14000 environment control program. Properly used and maintained, this product will provide years of accurate weighing. Handle it as you would any piece of fine electronic equipment.

Please READ this manual BEFORE operating or servicing this equipment. Follow the instructions carefully and save this manual for future reference.

We at **MT Xpress** want to make sure you received the product you expected. It is important to us that you are satisfied with your purchase. If there is anything we can help you with, or if you are not satisfied with either your product or the services received from the **Xpress** representative, let us know.

How can you reach us?

XPRESS CUSTOMER CARE CENTER, USA















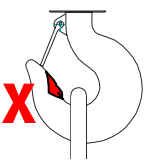

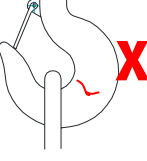
24/7 Information and Support: www.mt.com/xpress
xpress@mt.com

8 AM to 8 PM EST Toll Free: 1-866-MTXPRESS

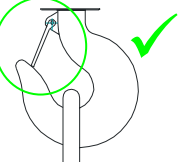
Xpress
Mettler-Toledo, Inc.
60 Collegeview
Westerville, OH 43081

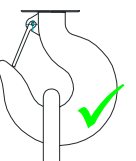
FCC Approval

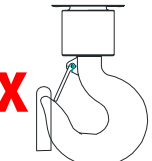
This device complies with part 15 of the FCC Rules. Operation is subject to the following two conditions: (1) this device may not cause harmful interference, and (2) this device must accept any interference received, including interference that may cause undesired operation.

	<p style="text-align: center;"> WARNING</p> <p>ONLY PERMIT QUALIFIED PERSONNEL TO SERVICE THIS EQUIPMENT. EXERCISE CARE WHEN MAKING CHECKS, TESTS, AND ADJUSTMENTS THAT MUST BE MADE WITH POWER ON. FAILURE TO OBSERVE THIS PRECAUTION COULD RESULT IN BODILY INJURY.</p>
	<p style="text-align: center;"> WARNING</p> <p>NEVER LIFT MORE THAN THE CRANE SCALE'S ASSIGNED WORKING LOAD LIMITED (WLL) RATING.</p>
	<p style="text-align: center;"> WARNING</p> <p>DON'T USE ANY LOAD BEARING COMPONENT THAT IS WORN BEYOND 5% OF THE ORIGINAL DIMENSION.</p>
	<p style="text-align: center;"> WARNING</p> <p>DO NOT USE THIS PRODUCT IF ANY OF THE COMPONENTS ARE CRACKED</p>
	<p style="text-align: center;"> WARNING</p> <p>NEVER POSITION THE LOAD OVER A HUMAN OR ANY BODY PART</p>
	<p style="text-align: center;"> WARNING</p> <p>BOTH THE CRANE AND SCALE SAFETY LATCHES MUST BE IN GOOD CONDITION AND IN PLACE.</p>
	<p style="text-align: center;"> WARNING</p> <p>THE CRANE SCALE HOOK MUST ALWAYS SUPPORT THE LOAD CORRECTLY.</p>
	<p style="text-align: center;"> WARNING</p> <p>THE SAFETY LATCH MUST NEVER SUPPORT THE LOAD.</p>

	<p style="text-align: center;"> WARNING</p> <p style="text-align: center;">LOADS MAY DISENGAGE FROM CRANE SCALE HOOK AND SHACKLE IF PROPER PROCEDURES ARE NOT FOLLOWED.</p>
	<p style="text-align: center;"> WARNING</p> <p style="text-align: center;">DO NOT LET LOADS SWING.</p>
	<p style="text-align: center;"> WARNING</p> <p style="text-align: center;">DO NOT LEAVE THE CONTROLS WHILE A LOAD IS SUSPENDED</p>
	<p style="text-align: center;"> WARNING</p> <p style="text-align: center;">LOADS MAY DISENGAGE FROM CRANE SCALE HOOK AND SHACKLE IF PROPER PROCEDURES ARE NOT FOLLOWED.</p>
	<p style="text-align: center;"> WARNING</p> <p style="text-align: center;">OPERATE THE CRANE AT A SAFE SPEED.</p>

CONTENTS

PREPARING THE SCALE FOR USE	9
UNPACKING	9
POWER SUPPLY	12
HANGING THE SCALE	12
SIZING THE SCALE (Important note.)	12
VERIFYING THE SCALE	13
CALIBRATING THE SCALE	13
TURNING THE SCALE ON/OFF	13
ZERO FUNCTION	14
RECOMMENDATIONS FOR USE	14
BATTERY NOTICE	14
SAFETY NOTICE	15
YOUR XPRESS SCALE AT A GLANCE	15
HANDLING HOIST MOTION	15
DISPLAY	16
CURSORS	16
KEYBOARD	17
REMOTE CONTROLLER (optional)	18
OPERATING YOUR SCALE	19
PUSH-BUTTON TARE	19
NUMERIC TARE	19
CLEAR (Removal of Tare Weight)	19
WEIGHING (Normal Gross Weight)	19
ACCUMULATING	19
MANUAL TOTAL	19
AUTO TOTAL	20
RECALL	20
CLEAR THE ACCUMULATOR	21
PEAK WEIGHING OPERATION	21
LOAD HOLD	21
SELF TEST	21
SLEEP MODE	21
BRIGHTNESS ADJUSTMENT	21
TURNING THE SCALE OFF	22
SCALE SOFTWARE SETUP	23
SETUP PARAMETERS OVERVIEW	23
TO ENTER MASTER MODE	24
SPECIAL FUNCTION GROUP	24
CLEANING AND MAINTAINING YOUR SCALE	29
REGULAR MAINTENANCE AND INSPECTION	29
CLEANING	30
POWER SUPPLY AND CHARGING	30
TROUBLESHOOTING	30

SERVICING YOUR SCALE	31
TO ENTER SERVICE MODE.....	31
CALIBRATION GROUP.....	32
DISPLAYS.....	35
APPLICATION GROUP.....	37
BATTERY REPLACEMENT.....	39
APPENDIX	40
DEFAULT SETUP PARAMETERS.....	40
ERROR MESSAGES.....	41
SPECIFICATIONS.....	42
GEO VALUE TABLE.....	43
PHYSICAL DIMENSIONS.....	44

Please follow the proper loading procedure:

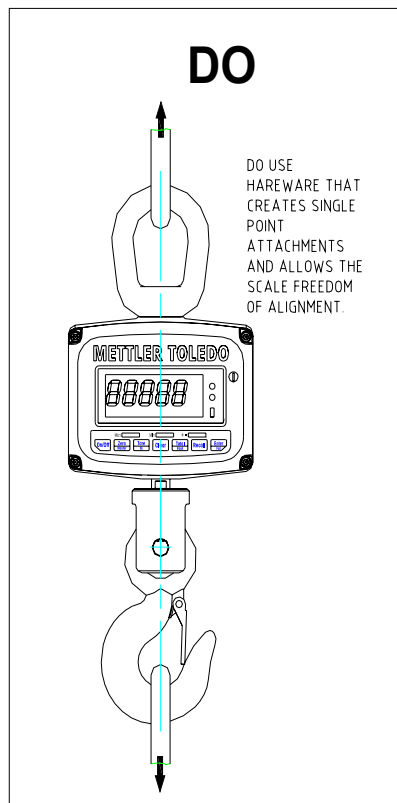
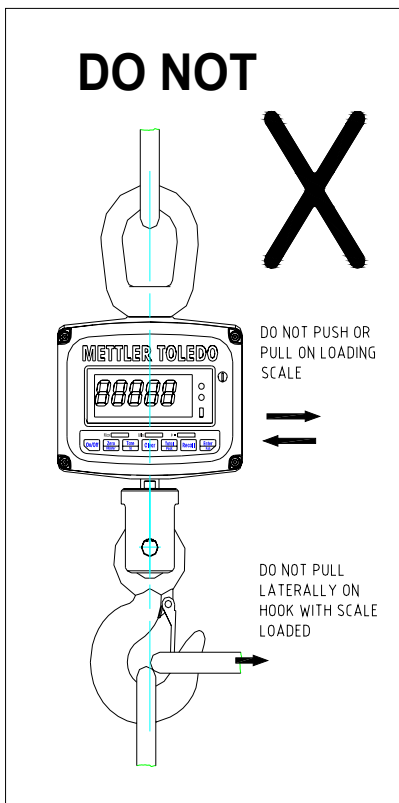
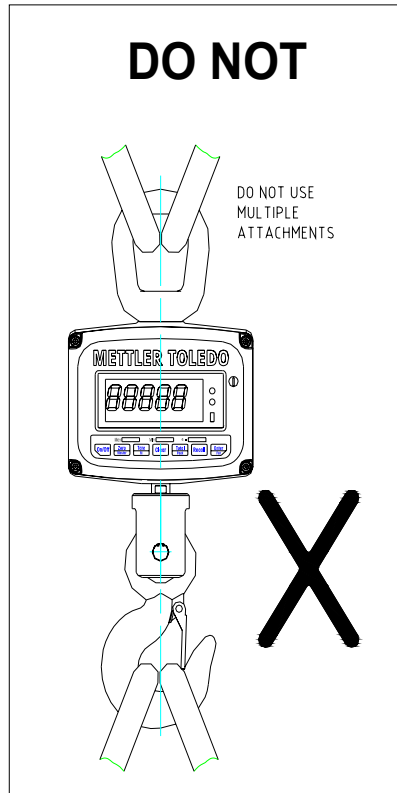
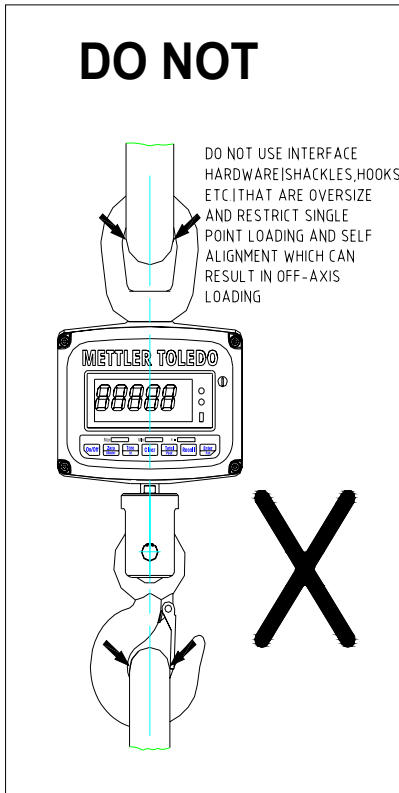

PREPARING THE SCALE FOR USE

The XCM Crane Scale is a weighing instrument used to weigh a load hung from its bottom hook while suspended safely from its top shackle. Weight is displayed directly on the scale body. It consists of scale body (including the indicator), shackle & hook, load cell, remote controller (Optional), etc. The scale body is made up of three separate sections that house the electronics, load cell and battery. The sections are bolted together and sealed against moisture by the use of O-rings.

The XCM integrated crane scale has features such as precise unambiguous indication, quick response time, unprecedented versatility, durability and reliability, ergonomic shape, low power usage, convenience of use and simple maintenance.

The XCM crane scale can be used in harsh environments such as steel mills, recycling plants, scrap metal facilities, ocean ports, and the fishing industry.

UNPACKING

This device is compact and relatively heavy; please take every precaution to insure that you do not strain your back

- Have two people remove the scale from the shipping container
- Use a power-lifting device such as a crane or forklift.
- Secure the scale to insure it doesn't drop when lifting.
- Do not stand under the scale

When unpacking the scale from the shipping container, insure that all parts are accounted for. Check the scale for any visible damage and immediately report to your shipper. Any questions, please contact your local **Xpress** Representative.

Package contents for all **Xpress** Economy Crane Scales include:

<u>Product</u>	<u>Documents</u>	<u>CD-ROM</u>
– Crane Scale	– Quick Start Guide	– Operation & Service Manual
– Upper Shackle	– Installation Instructions	
– Lower Hook		
– Remote Controller (Optional)		
– Transformer (Charger)		

Front view of the Crane Scale

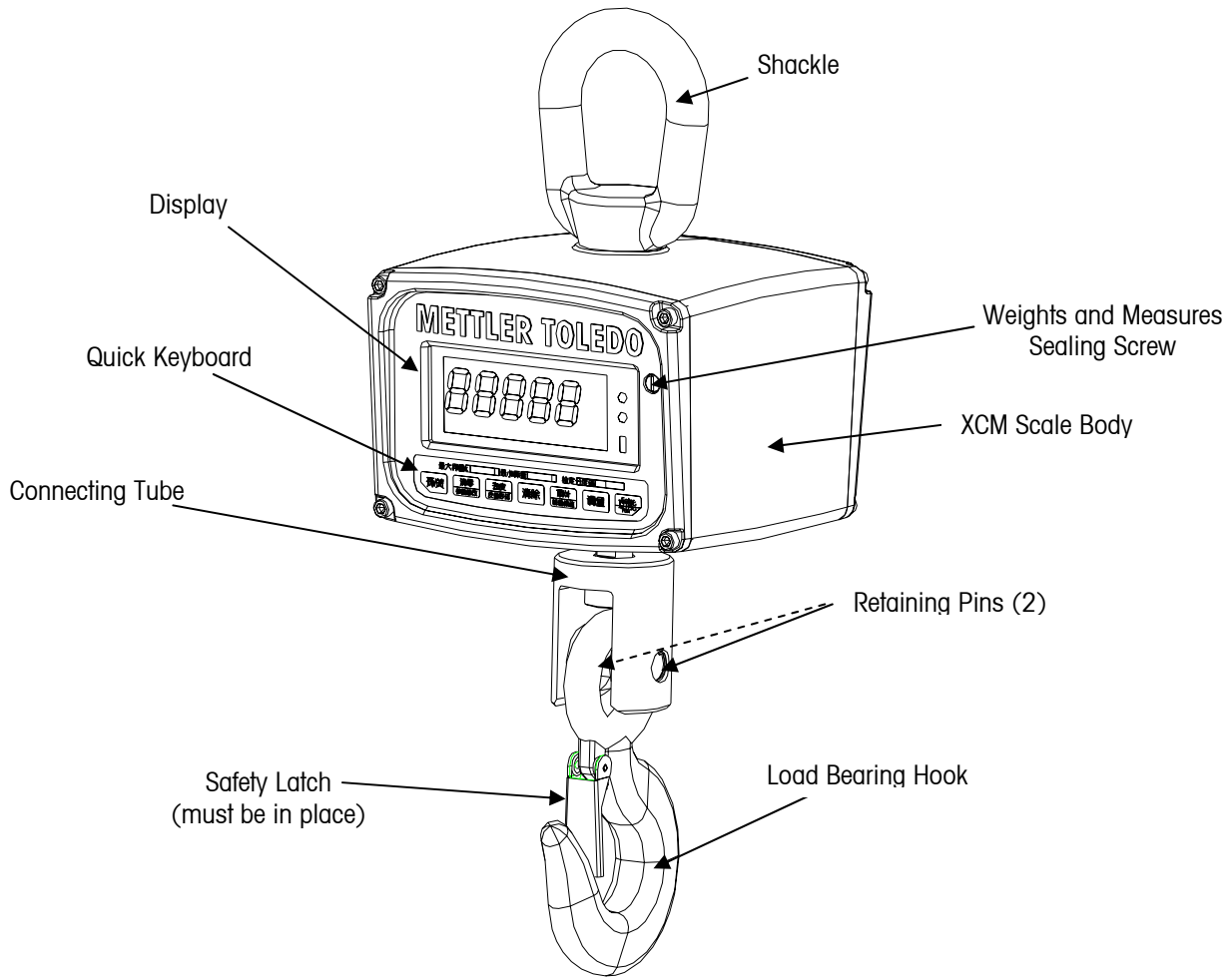

Rear view of Crane Scale

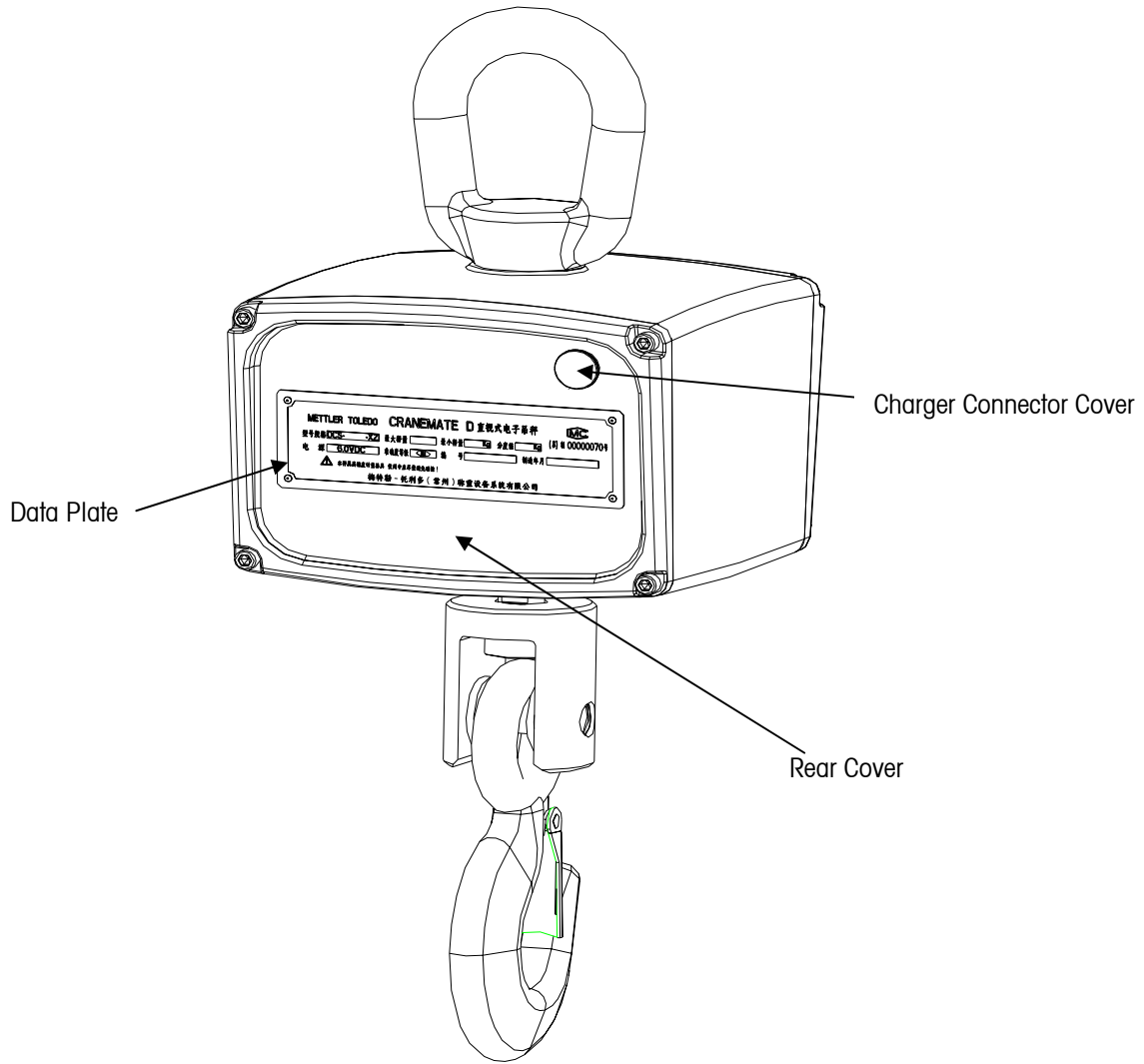

■ POWER SUPPLY

A sealed, rechargeable lead-acid battery (6V 7Ah) powers the scale and is fastened into the back of the scale by four screws in the rear cover. When charging the battery for the first time be sure to reference the section on usage and maintenance for the battery for more details. After considerable usage this battery may need to be replaced should it begin not holding a charge.

■ HANGING THE SCALE

Hang the scale from the bottom hook of a crane, and lock the secure latch to prevent the scale from falling from the hook. The secure latch is a safety feature of the hook on the crane. If your crane does not have a safety latch, or the safety latch is damaged, we recommend that you contact the crane manufacturer to obtain a hook with this safety feature.

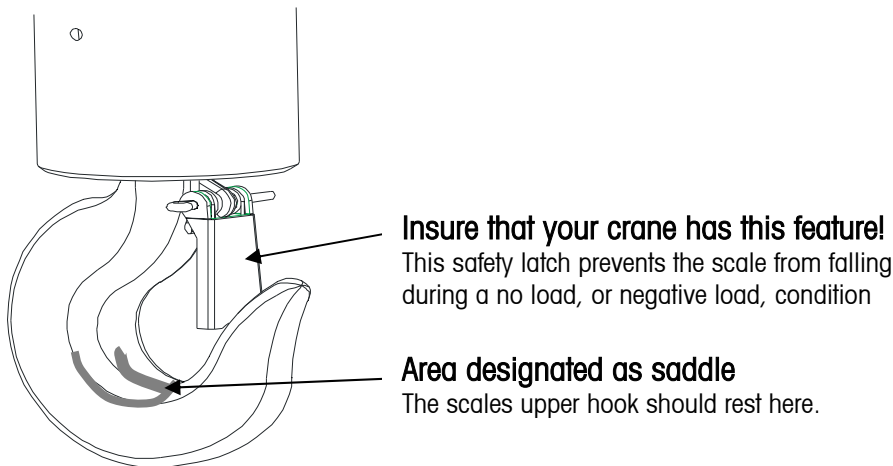

■ SIZING THE SCALE (Important note)

The scale capacity should be equal or greater than the lifting capacity of the crane. For Example: If your crane has a lifting capacity of 1.5 tons we recommend that you chose a 2-ton scale. If you have selected a scale that has a gross capacity that is less than your crane lifting capacity, please contact your Xpress representative to obtain a larger unit. Xpress scales are available in various capacities up to 40 tons.

How to choose the correct crane scale size

Lifting capacity of the crane * Safety factor = Proper scale size.

*If your company has a safety program and regularly trains employees in safe crane operation and continually inspect safety related hardware for proper operation, use 1 for the safety factor.

If your employees are not trained in safe crane operation and could overload the crane, from time to time, use 2 or more as a safety factor.

■ VERIFYING THE SCALE

The scale has been calibrated in the factory. The end user can use it after installation and verification. In situations where the weight is used for trading purposes, a verification procedure must be performed by local or national officials, or by an approved organization. After passing the verification and granted the metrological certificate, the scale can be used. Use for non-trade, the end user can use the scale after verification with known test weights.

■ CALIBRATING THE SCALE

Usually the end user shouldn't calibrate the scale after installation, except for using the scale for the first time and performing calibration cycle. An Xpress representative normally performs this. The user must have some test weights and lifting equipment for calibration. Pick up test weights of at least 20% of scale capacity when calibrating the scale. Test weights of 80% or more of capacity are recommended. If you notice that the scale is not linear it is possible to perform a three-point calibration. See Appendix "Factory Default Settings".

■ TURNING THE SCALE ON/OFF

Press , the scale powers up, the display is illuminated all, then displays the component number and the software version number e.g. "Sr L.1", then performs a series of self test, if everything is OK, the display returns to normal operating condition.

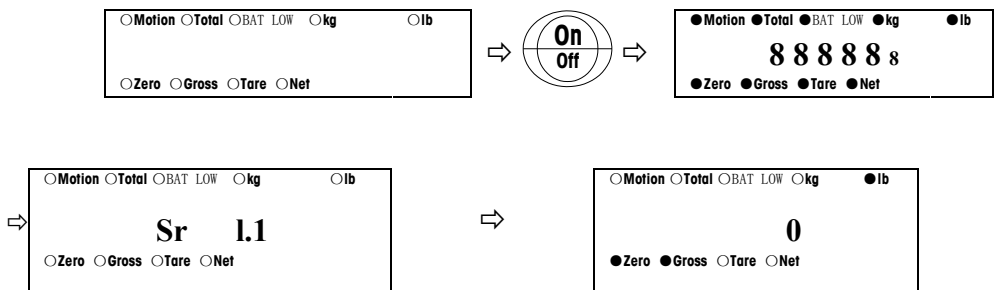

ZERO FUNCTION

Power-up Auto Zero

The scale has power-up auto zero function. Zero range must be less than the preset value in the setting F1.6.3.

Manual Push-Button Zero

In the Gross Mode, press  if the Gross value is within the zero range. The display will read zero and the Zero cursor should light.



The scale will not accept a zero, or tare command, when the item being weighed is moving. The motion lamp lights to indicate that the item is in motion.

In the Gross Mode, if the zero lamp is not lit, it is best to press 'Zero' to obtain the desired result. The zero lamp will light only when the load is $0 \pm 1/4$ displayed increment.

RECOMMENDATIONS FOR USE

- The end user should not calibrate the scale unless specifically trained on the calibration of this product.
- When calibrating the scale linearly please perform multi-point linearization.
- Notices for charging the scale battery:
- When the battery icon "L BAT" lights, the battery should be replaced.
- Do not recharge the battery until it has been fully discharged – this will shorten battery life.

BATTERY NOTICE

- The (6V/5Ah rechargeable lead-acid battery) battery service life will be affected by the charge and discharge conditions. When used properly, it can be effectively charged/discharged 300 times before operating time is significantly reduced;
- The new battery can provide continuous operation once it is fully charged. The charge time is usually 15 hours if the battery is fully discharged. The charge time will be shorter if the battery is not fully discharged.
- Do not short the positive pole (+) and negative pole (-) when replacing the battery.
- Charge the battery at least every 3 months to keep it in good condition.
- The battery charge is shorter than normal if the battery is not used for a long time, e.g. more than 2 months. At this time, please cycle battery at least three times by charging it and using it until fully discharged. This returns the battery to the normal operating condition.
- The battery is not warranted due to its service time, which is greatly influenced by individual use.
- The battery charge and scale operating duration will decline with use as is typical with lead-acid batteries. We recommend replacement of the battery after 300 charging cycles. Replacement batteries are available from your local **Xpress** representative.
- If the keyboard is not in use and the weight hasn't changed for five minutes, the scale will go into power-saving mode and will display "SLEEP". It can be reactivated by pushing any key on the quick keyboard or by operating the remote control.

YOUR XPRESS SCALE AT A GLANCE

SAFETY NOTICE

Before operating the XCM Crane Scale, the scale operator should carefully read and follow the operating precautions listed below:

- Follow all local and national safety laws.
- Follow all safety precautions from the crane manufacturer.
- Do not lift beyond rated load capacity of the crane, crane scale, sling chains, cables, or any item attached to the XCM Crane Scale, etc.
- Do not operate the scale in areas designated for pedestrians – these are usually marked.
- Do not position or maneuver the scale, or load, over any personnel.
- Do not operate the crane scale if ropes, slings, cables, chains, etc. show any sign of defects or excessive wear.
- Before moving the load, make certain that load slings, load chains, or other lifting devices are fully seated in the saddle of the crane scale hook with hook latch closed.
- Do not drop the load when attached to the crane scale
- Do not lift the load too rapidly.
- Do not collide the crane scale against any object.
- Don't operate the crane scale if ropes, slings, cables, chains, etc. show any sign of defects or excessive wear.
- Before moving the load, make certain that load slings, load chains, or other lifting devices are fully seated in the saddle of the crane scale hook with hook latch closed.
- At no time should a load be lift suspended from the crane scale unless the operator is at the crane's master switch or pendulum with the crane power on.
- Keep the load as close to the floor as possible to minimize the possibility of an injury, should the load drop.
- When the crane scale is holding a load, the crane operator should remain at the master switch or pendulum.
- When a hitcher is used, it should be the joint responsibility of the crane operator and the hitcher to see that hitches are secure and that all loose material has been removed from the load before starting a lift.
- Do not lift loads with ropes, slings, cables, and chains that are not securely fastened around or to the load.
- All ropes, slings, cables, chains, etc. should be removed from the crane scale when not in use.
- Do not use slings, cables, chains, etc. which have not been approved for lifting.
- Replace any damaged or worn items.
- Do not service or adjust the scale when a load is attached.

HANDLING HOIST MOTION

- After the crane scale hook has been positioned over the load, lower it until the load can be attached to the scale hook. As the scale hook approaches this level, reduce the speed so that the lowering can be stopped smoothly and quickly.
- If the slings are used to handle the load, the slings should be fully seated in the scale hook (saddle). With the scale hook latch closed, the scale hook should be started upward slowly until all slack has been taken out of the slings. Then ensure the load is properly balanced and the slings are properly positioned.
- Do not pull or push a load when it is attached to the scale.
- Do not allow the load to swing when it is being moved
- Do not make abrupt starts and stops with the crane that could cause the loss of control of the load or excessively strain the lifting mechanisms (ropes, slings, cables, chains, etc.)

■ DISPLAY

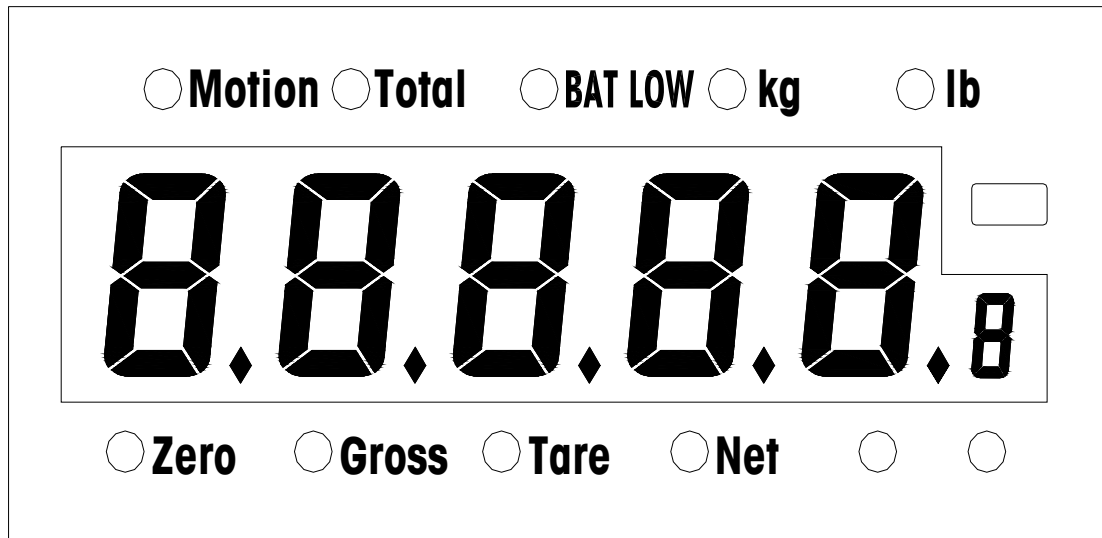

■ CURSORS

Zero	This LED lights when the scale is within $\pm 1/4$ d of gross zero.
Gross	This LED lights when the display is displaying gross weight.
Tare	This LED lights when the display is displaying tare weight.
Net	This LED lights when the display is displaying net weight.
Total	This LED lights when the display shows accumulated weight or total count.
Motion	This LED lights when the scale is in motion.
BAT LOW	This LED lights when the battery voltage is lower than the preset value.
Kg	This LED lights when the current weight unit is kg (kilograms).
lb	This LED lights when the current weight unit is lb (pounds).
8	Indicates the current accumulator No.

KEYBOARD

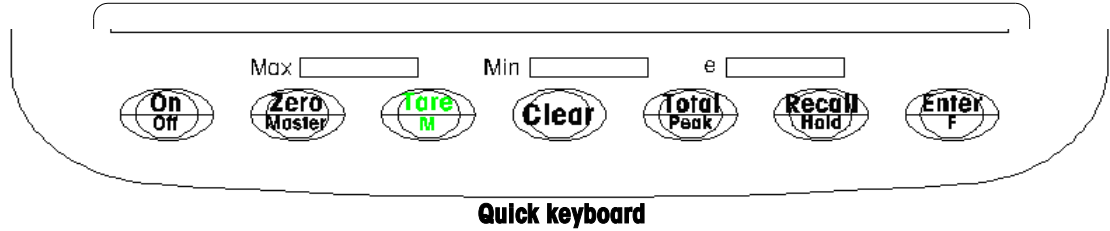

Keyboard function description:

Key	Function Description
On/Off	Turns the scale on or off.
Zero/Master	In the Gross Mode, press the key to set the zero reading of the scale.
Tare/M	Press the key in the Gross Mode to store the readings as the tare weight and to display on the instrument the net weight "0".
Clear	In the Net Mode pressing the key returns the instrument to the Gross Mode. In the Gross Mode, pressing this key begins the self-test.
Total/Peak	Press the key and the current weight reading is added to the accumulator. The LED indicator will flash for three seconds.
Recall/Hold	Pressing the key (on the instrument) repeatedly displays the tare value, the accumulated value and the total count in turn. Returns to the Weight Mode. When inputting data, pressing Recall the reading adds 1.
Enter/F + Zero/Master	Enter the Master Mode and you can modify some of parameters. (See Setup F3)
Enter/F + Tare/M	Proceed to check, store and recall the tare value.
Enter/F + Total/Peak	Enter the Peak Mold mode.
Enter/F + Recall/Hold	When the weight is stable, press Enter/F and Recall/Hold, the current readings are held. Press Clear key, the instrument quits the weight hold mode, and return the normal weighing mode.

REMOTE CONTROLLER (optional)

The remote controller can operate the scale as the quick keyboard does. In addition to the functions in the crane scale the remote control adds; 10 numerical key **0** to **9** plus **ID** and **Print** keys. Some operating modes, such as input of commodity ID's, numeric tare, and so on, are only accessed by the remote controller. These additional keys list as the following:

Off – Press the **Off** key and the scale powers down.

Note: the scale cannot power up via the remote controller.

Use the On/Off key on the quick keyboard to return the scale to use.

ID – Used to input commodity ID

Print – Does not function on this product

0 to **9** – Entry of tare weight, ID number and entry of capacity, added load when calibrating.

Other keys are the same as the quick keyboard.

The remote controller can be operated at distances up to 45 ft (15 m) from the scale. Its structure is fit for harsh industrial environments including corrosives, humidity, some shock loading, and dirt.

To test the controller press any key while observing the indicator light on the upper left-hand side of the control.

light every time a key is depressed, the batteries should be replaced. This unit requires two (2) AA Alkaline batteries. The batteries should be replaced every six months.

To replace the battery of the remote controller, take the remote controller from the yellow rubber housing. The procedure is as follows: Push the head of the remote controller slowly out of the rubber housing through the upper hole on the back of the housing, and pull the black controller out.

To avoiding changing the battery frequently, high-energy alkaline cells are recommended. After replacing the battery, slip the remote controller into the housing again.

If the remote control fails to function, clean the small window on the front of the scale and on the front of the controller with alcohol and a clean cloth.

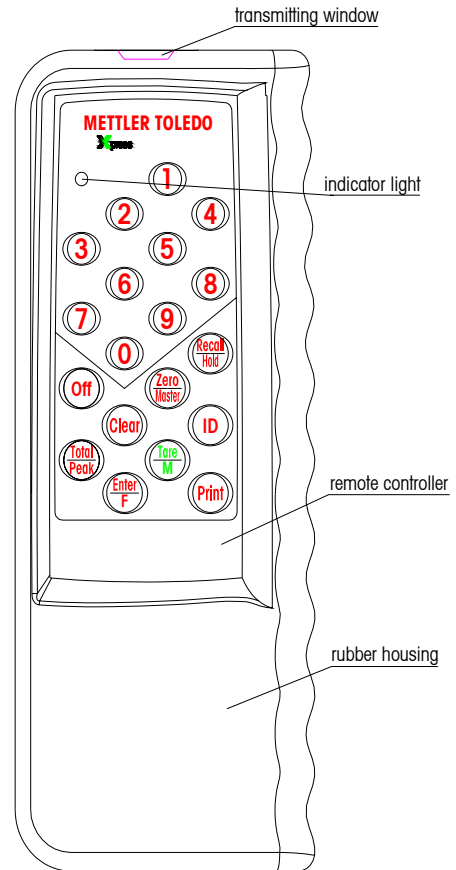

Remote controller

light on
If it fails to



When operating the remote controller, please aim the transmitting window at the infrared receiving window in the bottom portion of the front housing!

OPERATING YOUR SCALE

■ PUSH-BUTTON TARE

In Gross Mode, pressing **Tare** on the instrument stores the weight reading as the tare value. The net cursor lights and the scale displays zero.

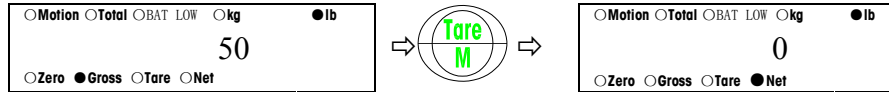

Tare will not function when the scale is in motion.

■ NUMERIC TARE

Press the numeric keys on the remote controller to input a manual tare value. Then press the **Tare** key.

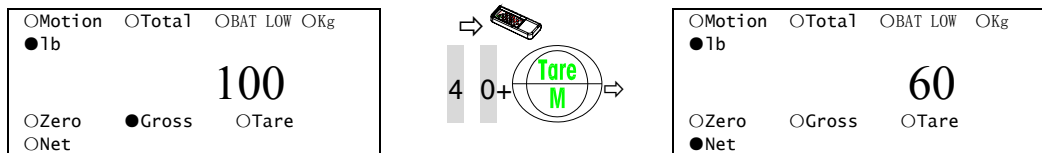

■ CLEAR (Removal of Tare Weight)

In Net mode, pressing **Clear** on the instrument clears the tare weight and displays the gross weigh. The GROSS cursor should light.

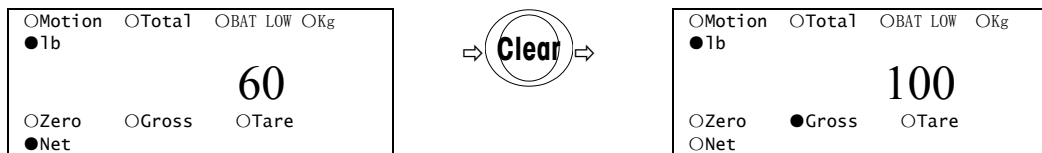

■ WEIGHING (Normal Gross Weight)

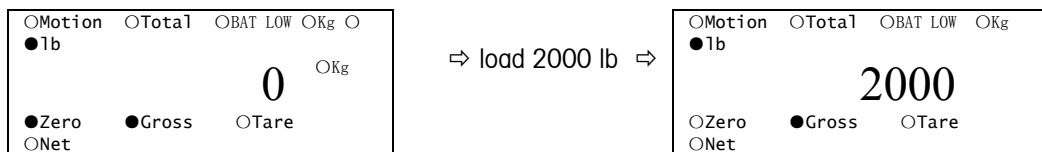

■ ACCUMULATING

The accumulation function should be operated in Normal Weighing or Set Point Mode. See setup step. ([F2.5 X], X=0 or 2)

■ MANUAL TOTAL

In the Gross or Net Mode, press **Total** and the weight readings are added to the corresponding accumulator (default value: 0), and at the same time the total count adds 1.

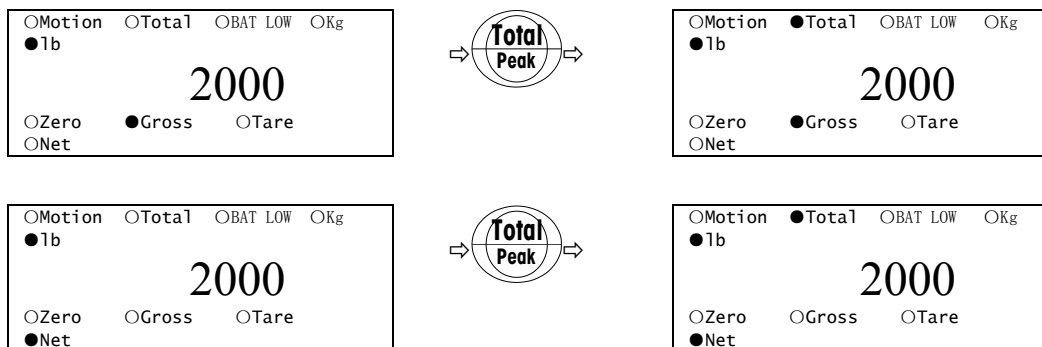

AUTO TOTAL

This operation must be in Auto Total mode. (See the setting F2.4.2 x=2.)

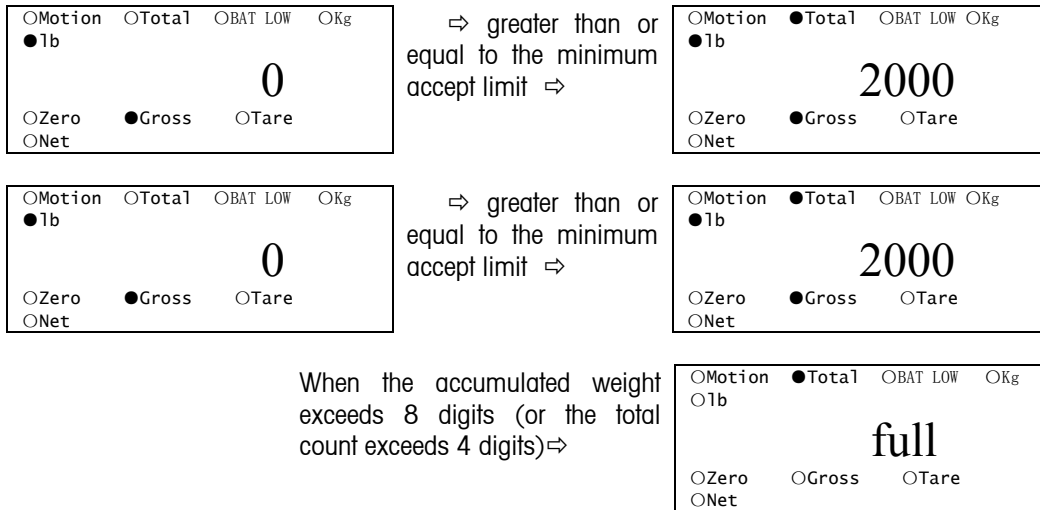

- After accumulating, the weight readings are added into the accumulator (default value: 0), and the total count automatically adds 1.
- When the readings are stable and greater than or equal to the minimum accepted limit, the weight readings can be accumulated. (See the Setup F2.4.1.)
- Only if the weight readings fall below 10 divisions, then return to above the minimum acceptance limit and are stable, the next readings can be accumulated automatically.
- When the accumulated weight exceeds 8 digits (or the total count exceeds 4 digits), the instrument displays "FULL". At the same time the LED flashes for five seconds (illuminating for half a second, blanking for half a second), indicating that the accumulator is full and that the last accumulation is invalid. Clear the accumulator at this time.

RECALL

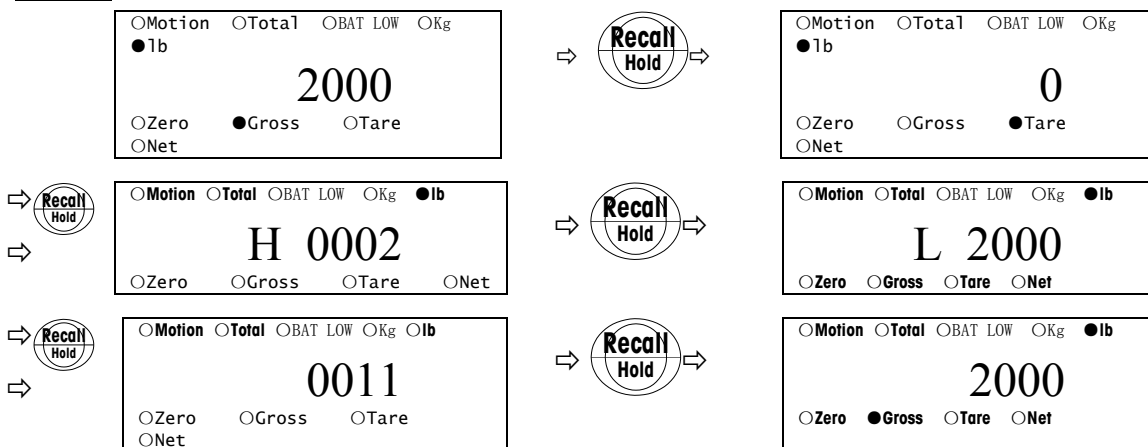

CLEAR THE ACCUMULATOR

When accumulation function is enabled ([F2.4.2 X] X=1 or X=2)

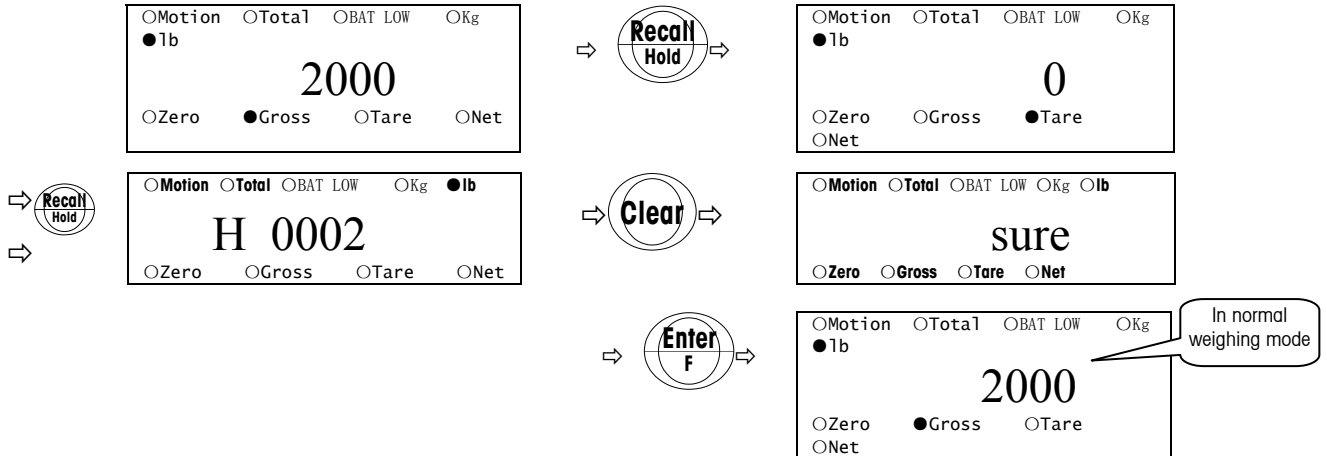

PEAK WEIGHING OPERATION

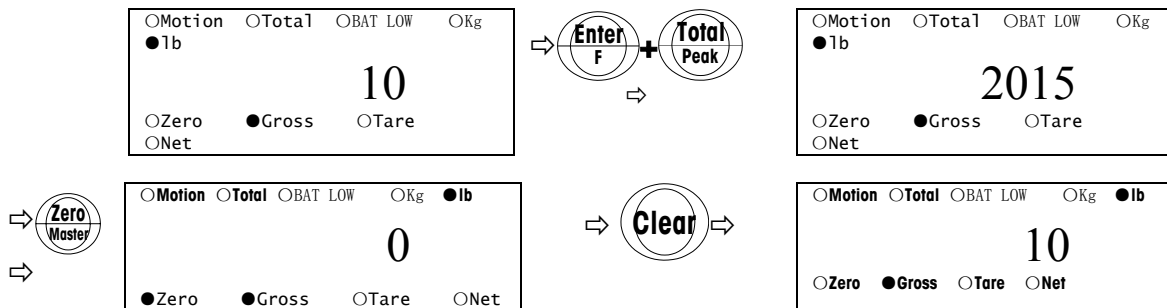

LOAD HOLD

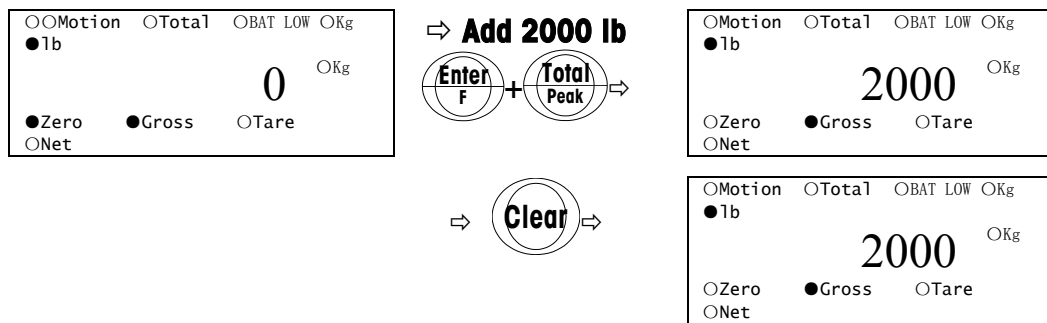

SELF TEST

In Gross Mode, press **Clear** and the instrument begins the self test. The display reads "00000", "11111", ..., "99999", "-----", cursors and the remaining battery capacity messages [bAt X] (X=4, 3, 2, 1, 4-high 1-low). The instrument will return to the normal weighing mode automatically.

SLEEP MODE

If the keyboard isn't in use and the weight hasn't changed for five minutes, the scale will go to power-saving mode and the display will show "SLEEP". The scale can be awoken by use of pushing the quick keyboard or operating the remote controller. To disable the SLEEP function, select the parameter "0" in the Setup F3.1.

BRIGHTNESS ADJUSTMENT

To adjust the brightness, select the parameter "0" or "1" in the Setup F3.2. See Appendix "Factory Parameters Setup" and "Factory Default Settings". The default parameter "0" indicates bright LED, the parameter "1" indicates bright LED and the LED brightness will darken automatically if the weight isn't obviously changed for five minutes, the parameter "2" indicates the LED brightness can be adjusted automatically according to ambient light levels.

■ TURNING THE SCALE OFF

Pressing **On/Off** on the quick keyboard or **Off** on the remote controller causes the scale to power down and the display will be blank.

SCALE SOFTWARE SETUP

In the Master Mode, only parameters F3, F4, F5, and F6 can be changed. To change the parameters F1 and F2, refer to "Servicing your Scale".

SETUP PARAMETERS OVERVIEW

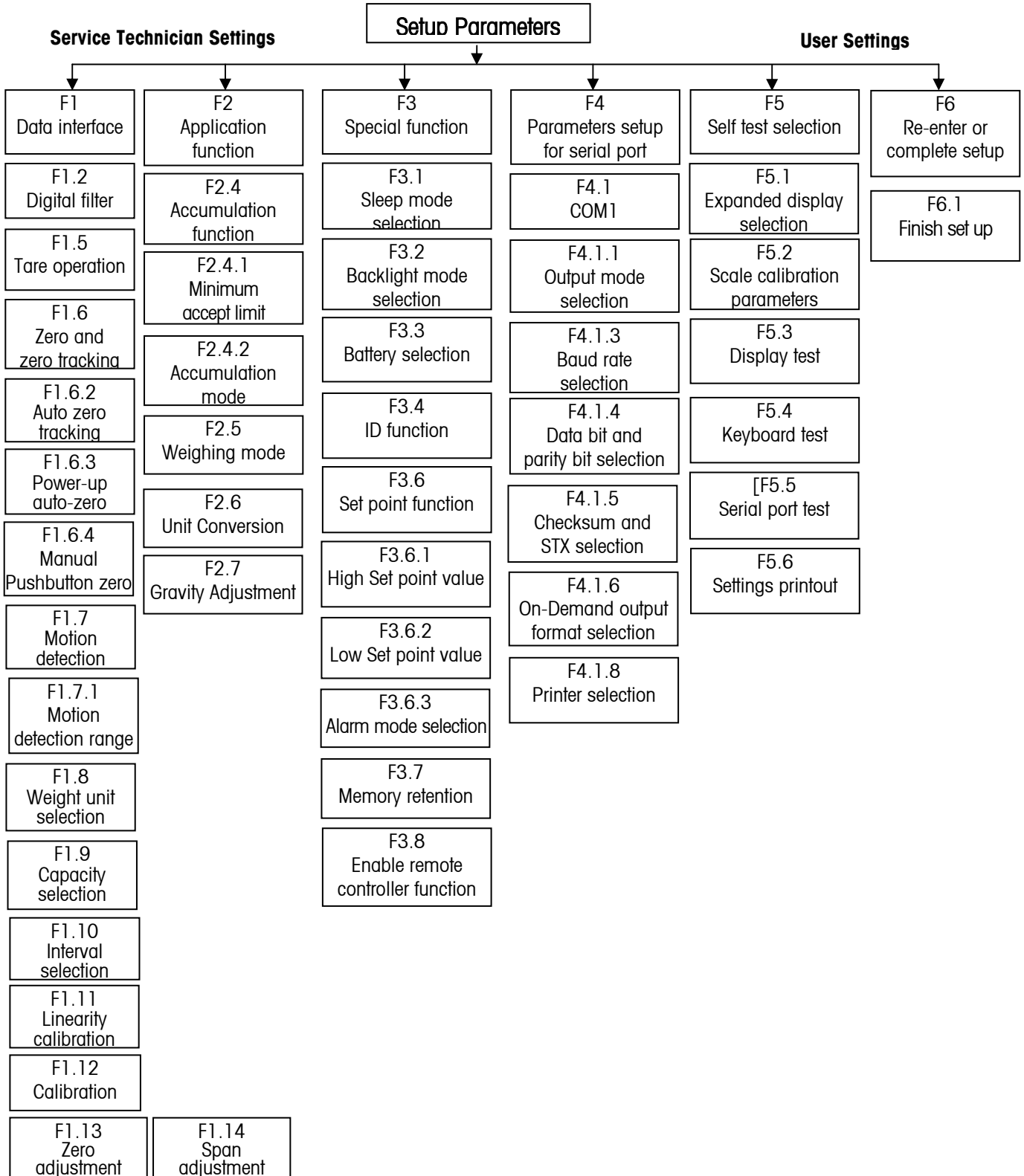

■ TO ENTER MASTER MODE

Press **Enter/F**, **Zero/Master** in turn and the instrument displays "F3.1" and enters the Master Mode. Many of the parameters, such as F3, F4, F5, can be modified. To modify the parameters F1 and F2, the scale must be in Service Mode. (See Servicing Your Scale.)

During setup, the function of each key lists as below:

Tare key—Used to select setup group or setup parameters

Zero key—To step back through the setup procedure

ENTER/F key—To confirm the selected parameter

When inputting numerical data:

Tare key—The flashing digit shifts one digit to the left; this digit can be modified

Recall key—The flashing digit increments on each depression

■ SPECIAL FUNCTION GROUP

[F3] Special Function

Press: **Tare**—Skips to step [F4]

Enter—Advances to step [F3.1]

Zero—Returns to step [F2]

[F3.1 X] Sleep Mode Selection

Press: **Tare**—Displays next selectable parameters:

0—Disables sleep mode

1—Enables sleep mode (default)

If the keyboard isn't in use and the weight isn't obviously changed for five minutes, the instrument will sleep and display "SLEEP", and can be awoken by use of pushing the quick keyboard or operating the remote controller.

Enter—Accepts the selected parameter, advances to step [F3.2 X]

Zero—Returns to step [F3]

[F3.2 0] Brightness Adjustment

Press: **Tare**—Displays next parameter, selectable parameters:

0—Brightness adjustment off (default)

1—Brightness adjustment on. The brightness will be off automatically after the weight isn't changed for five minutes.

2—Auto on/off (bright/dim according to ambient light levels)

Enter—Accepts the selected parameter, advances to step [F3.3 X]

Zero—Returns to step [F3.1 X]

[F3.4 0] ID function

Press: **Enter**—Disables ID function. Advances to step [F3.6] in Set point mode or to step [F3.7],

Tare—Displays [F3.4 1]. Press **Enter** key to enable ID function in Set Point Mode advances to step [F3.6], or to step [F3.7 X].

When you disable the ID function remember that each tare memory and accumulator has only one and the default number is zero.

Note: The function is only for the Service Mode.

[F3.6] Set Point Function (External Output is only available via an option kit)

Press: **Tare**—Disables Set point function, skips to step [F3.7 X].

Enter—Enables Set point function, displays [F3.6.1].

Note: The function is only for the Service Mode.

[F3.6.1] Inputting the high Set Point Value

After one second the instrument displays:

[000000]—Use the **Tare** and **Recall** key to input the high Set Point Value or key in the value directly from the remote controller. Press the **Enter** key to confirm and to advance to step [F3.6.2].

[F3.6.2] Inputting the low Set Point Value

After one second the instrument displays:

[000000]—Use **Tare** and **Recall** keys to input the low Set Point Value or to key in the value directly from the remote controller. Press the **Enter** key to confirm, advances to step [F3.6.3 X].

Note: Only after Set point mode is selected in step [F2.5 X] (set X=2), this function can be available. The high set point value must be greater than the low one.

[F3.6.3 1] Display Alarm Mode Selection

Press: **Tare**—Displays next selectable parameters:

0—The weight reading doesn't flash when the weight "reaches" the set point value.

1—The weight reading flashes on and off when the weight "reaches" the set point value.

Enter—Accepts the selected parameter and advances to step [F3.7 X]

Zero—Returns to step [F3.6]

The word "reaches" means that the weight reading is greater than or equal to the high Set Point Value, or less than or equal to the low Set Point Value.

[F3.7 0] Memory Retention

Press: **Enter**—Disables memory retention and advances to step [F3.8 X]

Tare—Displays [F3.7 1]. Press **Enter** key to enable memory retention and to advance to step [F3.8 X].

When Memory Retention is enabled, the instrument returns to the last status (Zero, Gross/Net status, etc.) when powering up.

Zero—Returns to step [F3.7]

[F3.8 1] Enable Remote Controller Function

Press: **Enter**—Enables the remote controller. The cursor “Remt” lights in normal operation and advances to step [F4].

Tare—Displays [F3.8 0]. Press the **Enter** key to confirm. Disables the remote controller and advances to step [F4].

Zero—Returns to step [F3.7 X]

Zero—Returns to step [F3]

Zero—Returns to step [F4]

[F4] Printer Selection is not used on this product

[F5] Self-Test Selection

Press: **Tare**—Advances to step [F6]

Enter—Enters the entry of self-test setup; displays [F5.1 X].

Zero—Returns to step [F4]

[F5.1 X] Expanded Display Selection

Press: **Tare**—Displays next selectable parameters:

0—Disables the expanded display (default)

1—Enables the expanded display. In weighing mode, the instrument displays internal scale interval.

Note: One display scale interval is equal to ten internal scale intervals.

Enter—Accepts the selected parameter, advances to step [F5.2 0]

Zero—Returns to step [F5]

[F5.2 0] Display Scale Calibration Parameters

Press: **Enter**—Skips to step [F5.3 0]

Tare—Displays [F5.2 1], press the **Enter** key; Displays [FinE0] then after two seconds displays [XXXXXX]; Records or modifies the empty scale reading. Press the **Enter** key to display [SPAN1]. After two seconds it displays [XXXXXX] and records or modifies the span coefficient. Then press **Enter** key again to display [LinE1]. After two seconds it displays [XXXXXX] and records or modifies the linearity coefficient No.1. Press the **Enter** key and it displays [LinE2] after two seconds displays [XXXXXX]. Record or modify the linearity coefficient No.2. Press the **Enter** key and advance to next step.

Zero—Returns to step [F5.1 X]

[F5.3 0] Display Test

Press: **Enter**—Advances to step [F5.4 0]

Tare—Displays [F5.3 1]. Press **Enter** key, the instrument enters the display test, displays all possible numbers from all zeros through all nines, then all cursors illuminates, performs internal checks on the memory, then advances to step [F5.4 0].

Zero—Returns to step [F5.2 0]

Note: If the instrument finds any errors during the memory check, it will display a corresponding error code.

[F5.4 0] Keyboard Test

Press: **Enter**—Advances to step [F5.5 0]

Tare—Displays [F5.4 1]. Press **Enter** key, the instrument enters the keyboard test, operators press a key, and the instrument displays a corresponding key code, press **Enter** key to end this test, advances to next step.

Zero—Returns to step [F5.3 0]

[F5.5 0] Serial Port Test (Not used on this product)

Press: **Enter**—Advances to step [F5.6 0]

Tare—Displays [F5.5 1]. Short-circuit TXD and RXD pin of the output connector, and press **Enter** key, the instrument enters the serial port test. The weight display reads the transmitting numeral on the two leftmost digits, and the receiving numeral on the two rightmost digits, the two numerals should be same. The display reading begins from "01", then "02", "03" ... "09", "00", "01", goes round and round. Press **Enter** key to end this test, advances to next step.

Zero—Returns to step [F5.4 0]

[F5.6 0] Settings Printout (Not used on this product)

Press: **Enter**—Advances to step [F6]

Tare—Displays [F5.6 1]. Press **Enter** key, the instrument outputs the settings.

Zero—Returns to step [F5.5 0]

[F6] Re- Enter or Complete Setup.

Press: **Tare**—Advances to step [F1] start over

Enter—Goes to [F6.1 X] finish setup

Zero—Returns to step [F5] previous selection

[F6.1 X] Finish Setup

Press: **Tare**—Displays next parameter, selectable parameters:

1—Saves your selection

2—Restores the previous parameters

3—Restores the factory default, displays "SvrE?" (Save).

Enter—Accepts the selected parameter

Zero—Returns to step [F6]

If item 1 or 2 is selected, the scale quits the setup program and returns to normal weighing mode, If item 3 is selected, displays "SvrE?" (Save).

Press **Enter** key, the instrument restores the factory default parameters, and then quits the setup program, returns to normal weighing mode.

Press **Tare** key, returns to step [F6]

Quit the Setup Program

To quit the setup program and return to normal weighing mode, follow the procedure as below: press **Clear** key, displays [F6], press **Enter** key, displays [F6.1 1], to save the setup parameters, press **Enter** key, the scale quits the setup program and returns to normal weighing mode.

CLEANING AND MAINTAINING YOUR SCALE



REGULAR MAINTENANCE AND INSPECTION

Connection

Check the connecting pieces, split pins and set screws for looseness or deformity, and replace or tighten them at once.

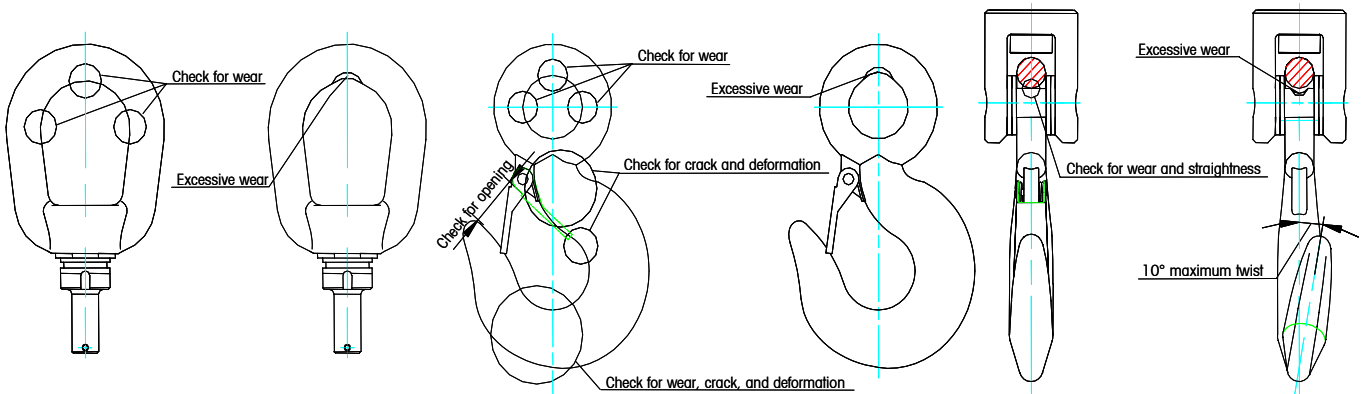

Surface Damage

Check the shackle & hook surfaces for mechanical damage such as cracks, etc. and discard the damaged ones and replace them!

Deformation

- Check the opening (See the upper figure) of the hook, when the value is 10% greater than the initial dimension, the hook must be discarded!
- Check the twist deformation of the hook, when the twist angle of the hook body is greater than 10°, the hook must be discarded!
- The shackle and hook should not have any plastic deformation, or they must be discarded!

Abrasion and Corrosion

- Check the shackle and hook for abrasion and corrosion, the actual dimensions in use on the dangerous section should not less than 95% of their initial dimension, or they must be discarded!
- DO NOT permit to repair the shackle and hook system by welding!
- Replace the secure latch periodically i.e., whenever it is damaged or broken. This will prevent the scale from falling should it encounter a no load or zero load.

CLEANING

Clean the keyboard with a soft cloth that has been dampened with a mild window cleaner or detergent. DO NOT use any type industrial solvent or chemicals.

Regular inspections and making records periodically by a qualified service technician are also recommended.

POWER SUPPLY AND CHARGING

A sealed rechargeable lead-acid battery (6V7Ah) powers the XCM Crane Scale. The operator ought often to check the remaining battery capacity. Change the battery in time when the low battery indicator “●” lights. When the scale displays [L Bat], indicating that the battery capacity is too low for the scale to work, the battery must be charged immediately or the scale will power down automatically.

Charging

Remove the plastic cap on the rear cover plug in the charger shipped with the scale into power outlet, than plug another small end of the charger’s power cord into the charging port of the battery, now start to charge the scale. The charger indicator is red when charging; when the indicator turns yellow, charging is complete.

WARNING

- Charge the battery if the scale has been not in use for more than three months.
- Charging time: 24 hours.
- Daily charging time: 8 to10 hours at 20°C above; 12 to16 hours at 20°C below.
- Keep the battery away from heat source; avoid exposure to the sun.
- When not in use for a long time, DO remove the battery.

Remote Controller Power Supply

Two ordinary alkaline cells (“AA” size, 1.5V) are needed for the Remote Controller. If the indicator light does not flash when operating the remote controller, the battery must be immediately replaced.



TROUBLESHOOTING

The instrument is designed for durability and reliability, and virtually error free, If problems do occur after re-powering on, do not attempt to repair the scale or instrument before you have determined the source of the problem. Begin by performing the diagnostic tests described in Chapter above. If the problem persists, you can use the error codes table below to help identify the problem.

 WARNING	<p>If there is anything wrong with the crane scale, please contact the local Xpress representative.</p>
---	---

SERVICING YOUR SCALE

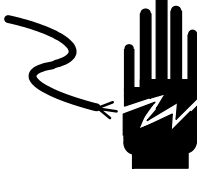
 For the following services, please contact your **Xpress** representative at www.mt.com/xpress.

	 WARNING
	DISCONNECT ALL POWER TO THIS UNIT BEFORE INSTALLING, SERVICING, CLEANING, OR REMOVING THE FUSE. FAILURE TO DO SO COULD RESULT IN BODILY HARM AND/OR PROPERTY DAMAGE.

 CAUTION
BEFORE CONNECTING OR DISCONNECTING ANY INTERNAL ELECTRONIC COMPONENTS OR INTERCONNECTING WIRING BETWEEN ELECTRONIC EQUIPMENT, ALWAYS REMOVE POWER AND WAIT AT LEAST THIRTY (30) SECONDS BEFORE ANY CONNECTIONS OR DISCONNECTION'S ARE MADE. FAILURE TO OBSERVE THESE PRECAUTIONS COULD RESULT IN DAMAGE TO OR DESTRUCTION OF THE EQUIPMENT, OR BODILY HARM.

TO ENTER SERVICE MODE

Remove the seal screw (see next figure) on the front cover and press the pushbutton in the hole, the instrument displays "F1" and enters the Service mode. All parameters including the calibration parameters can be modified.

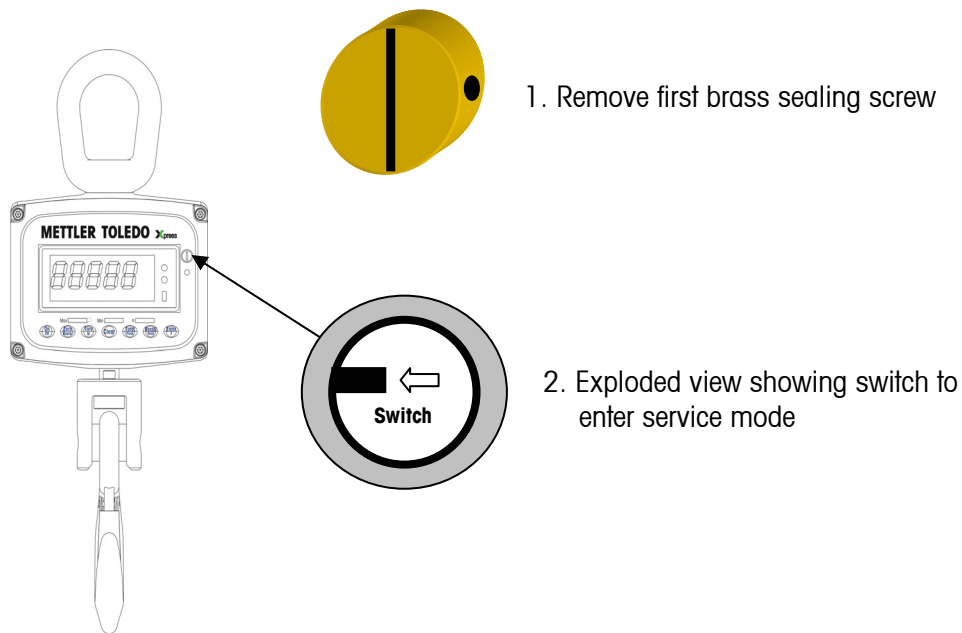

Entering service mode

Note: Entering Service mode voids weights and measures approval and the unit must be reprovved.

Remove the hexagonal seal screw (see Figure) on the right side of the front cover and press the push button in the hole, the instrument displays "F1" and enters the Service mode. All parameters including the calibration parameters can be modified.

During the setup, the function of each key lists as below:

Tare key—Used to select setup group or setup parameters,

Zero key—To step back through the setup procedure,

ENTER/F key —To confirm the selected parameter,

When inputting numerical data:

Tare key —The flashing digit shifts one digit leftwards, this digit can be modified.

Recall key—The flashing digit increments on each depression.

Note: in the following description, the **`F'** in **`[FX.X]'** displays on the far left side of the display.

■ CALIBRATION GROUP

[F1] Weighing Functions

Press: **Tare** — Skips to step [F2]

Enter — Enters the calibration group, displays [F1.2 X]

[F1.2 X] Digital Filter

Press: **Tare** — Displays next digital filter parameter, selectable parameters:

0 — Filter disabled

1 — Light filter

2 — Medium filter (default)

3 — Heavy filter

Enter — Accepts the selected parameter, enters step [F1.5 X]

Zero — Returns to step [F1]

[F1.5 X] Tare Operation

Press: **Tare** — Display next selectable parameters:

0—Disables tare operation

1—Enables tare operation, tare range: 0~100% F.S.(default)

Enter—Accepts the selected parameter, enters step [F1.6]

Zero—Returns to step [F1.2]

[F1.6] Zero and Zero Tracking

Press: **Tare** — Skips to step [F1.7]

Enter — Enters next step, displays [F1.6.2 X]

[F1.6.2 X] Auto Zero Tracking

Press: **Tare** — Displays next selectable parameters:

- 0 — Disables auto zero tracking (default)
- 1 — Zero tracking threshold value: $\pm 0.5d$
- 2 — Zero tracking threshold value: $\pm 1.0d$
- 3 — Zero tracking threshold value: $\pm 3d$

Enter — Accepts the selected parameter, advances to step [F1.6.3 X]

Zero — Returns to step [F1.6]

[F1.6.3 X] Power-up Auto Zero

Press: **Tare** — Displays next selectable parameters:

- 0 — Disables power-up auto zero
- 1 — Power-up auto-zero range: $\pm 2\%$
- 2 — Power-up auto-zero range: $\pm 10\%$ (default)
- 3 — Power-up auto zero range: $\pm 100\%$

Enter — Accepts the selected parameter, advances to step [F1.6.4 X]

Zero — Returns to step [F1.6.2 X]

[F1.6.4 X] Manual Push-button Zero

Press: **Tare** — Displays next selectable parameters:

- 0 — Disables manual pushbutton zero
- 1 — Manual zero range: $\pm 2\%$ (default)
- 2 — Manual zero range: $\pm 20\%$
- 3 — Manual zero range: $\pm 100\%$

Enter — Accepts the selected parameter, advances to step [F1.7]

Zero — Returns to step [F1.6.3 X]

[F1.7] Motion Detection

Press: **Tare** — Skips motion detection setup and advances to step [F1.8]

Enter — Enters motion detection setup, advances to step [F1.7.1 X]

[F1.7.1 X] Motion Detection Range

Press: **Tare** — Displays next selectable parameters:

- 0 — Disables motion detection
- 1 — Motion detection range: $\pm 0.5d$ (default)
- 2 — Motion detection range: $\pm d$
- 3 — Motion detection range: $\pm 3d$

Enter — Accepts the selected parameter, advances to step [F1.8 X]

Zero — Returns to step [F1.7]

[F1.8 X] Weight Unit Selection

Press: **Tare** — Displays next selectable parameters:

- 0 — Displays weight unit: kg
- 1 — Displays weight unit: lb
- 2 — Displays weight unit: t
- 3 — Displays weight unit: mt (metric tonne)

Enter — Accepts the selected parameter, advances to step [F1.9]

Zero — Returns to step [F1.7]

[F1.9] Capacity Selection

After two seconds displays the current capacity.

Press: **Tare** — Enters the entry of capacity and displays "000000". The leftmost digit flashes use **Tare** and **Recall** keys to input the capacity value, or key in the capacity value directly via the numerical key.

Enter — Confirms and advances to step [F1.10]

Zero — Cancels the selection, Returns to step [F1.8]

[F1.10] Interval Selection

After two seconds displays the current interval "XXXXXX".

Press: **Tare** — Displays next interval

Enter — Confirms the selected interval, advances to step [F1.11 X]

Capacity and interval selection must meet the values in the next table. The others are shown but are only available on heavier capacity units.

Interval \ Capacity	0.02	0.05	0.1	0.2	0.5	1	2	5	10	20	50
100	√	√	√								
250		√	√	√							
500			√	√	√						
1000				√	√	√					
2000					√	√	√				
2500					√	√					
3000						√	√				
5000						√	√	√			

Capacity and interval

[F1.11 X] Linearity Calibration

Press : **Tare** — Display next selectable parameters:

0 — Disables linearity calibration (default)

1 — Enables linearity calibration

Enter — Accepts the selected parameter, advances to step [F1.12 0]

Zero — Returns to step [F1.9]

[F1.12 0] Calibration (Do not use this step unless you have sufficient test weights - See below.)

Press: **Enter** — Skips to step [F1.13 0]

Tare — Displays [F1.12 1], press **Enter** again, the instrument enters the calibration procedure.

■ DISPLAYS**Standard Calibration (F1.11=0)**

[E SCL] — Remove all weight from the scale, press **Enter** key once the scale has settled and is stable, the instrument displays [15 SCL], counts down from 15 to 0 while recording zero, then displays [Add Ld].

Note: when displaying [E SCL], press **Zero** to return to step [F1.12 0].

[Add Ld] — Pick up test weights of at least 20% of scale capacity. A test weight of 80% or more of capacity is recommended for highest accuracy. Then press **Enter**, the instrument displays [000000], the leftmost digit flashes, use **Tare** and **Recall** keys to input the test weights value, or key in the value directly from the remote controller, then press the **Enter** key to confirm your selection, the instrument displays [15 S[L] , counts down from 15 to 0 while recording span, then displays [[AL d], indicating that the calibration is completed, and displays [F1.13 0] after 2 seconds.

Note: When displaying [Add Ld], press **Zero** to return to step [E SCL].

For best results, the test weight must relate to the lowest significant digit. A test weight not corresponding to the lowest significant digit will be automatically rounded to the closest digit. If the scale has a scale capacity yielding a lowest significant digit of 5kg then adding 4kg would cause an error.

Three-Point Linear Calibration (F1.11=1)

[E SCL] — Remove all weight from the scale, press **Enter** once the scale is stable, the instrument displays

[5 SCL], counts down from 15 to 0 while recording zero, then displays [Add HI].

[Add HI] — Pick up test weights of at least 50 to 100% of scale capacity. Test weights of 80% or more of capacity are recommended for highest accuracy. Then press **Enter**, the instrument displays [000000], the leftmost digit flashes, use **Tare** and **Recall** key to input the test weights value, or key in the value directly from the remote controller, then press **Enter** key to confirm, the instrument displays [15 SCL] , counts down from 15 to 0 while recording high span, then displays [Add L0].

Note: When displaying [Add HI], press **Zero** to return to step [E SCL].

For best results, the test weight must relate to the lowest significant digit. A test weight not corresponding to the lowest significant digit will be automatically rounded to the closest digit. If the scale has a scale capacity yielding a lowest significant digit of 5 kg then adding 4 kg would cause an error.

[Add L0] — Pick up test weights of at least 10 to 50% of scale capacity, then press **Enter**, the instrument displays [000000], the leftmost digit flashes, use **Tare** and **Recall** key to input the test weights value, or key in the value directly from the remote controller, then press **Enter** key to confirm, the instrument displays [15 S[L] , counts down from 15 to 0 while recording low span, then displays [[AL d], indicating that the calibration is completed, and displays [F1.13 0] after 2 seconds.

Note: When displaying [Add L0], press **Zero** to return to step [Add HI].

For best results, the test weight must relate to the lowest significant digit. A test weight not corresponding to the lowest significant digit will be automatically rounded to the closest digit. If the scale has a scale capacity yielding a lowest significant digit of 5 kg then adding 4 kg would cause an error.

[F1.13 0] Zero Adjustment

Press: **Enter** — Skips to step [F1.14 0]

Tare — Displays [F1.13 1], advances to zero adjustment. Remove all weight from the scale, press **Enter** key, the instrument displays [15 S[L] and counts down from 15 to 0 while recording zero, then displays [F1.14 0].

Zero — Returns to step [F1.12 0]

[F1.14 0] Span Adjustment

Press: **Enter** — Skips to step [F2 0]

Tare — Displays [F1.14 1], advances to span adjustment.

Press **Enter** key, the instrument displays [000000], use **Tare** and **Recall** key to input the test weights value, or key in the value directly from the remote controller, press **Enter** to confirm, the instrument displays [15 S[L] and counts down from 15 to 0 while recording span, then advances to next step.

Zero —Returns to step [F1.13 0]

Note: Pick up test weights on the scale in weighing mode, then enters the Setup, advances to step [F1.14 0], repeat the span adjustment operation following the above step.

Warning: The test weight value must be divided exactly by significant figure of the selected scale interval. For example, significant figure of scale interval 0.02 is 2.

■ APPLICATION GROUP

[F2] Application Function

Press: **Tare** — Skips to step [F3]

Enter — Enters application group, displays [F2.4]

[F2.4] Accumulation Function

Press: **Tare** — Disables accumulation function, advances to step [F2.5]

Enter — Advances to step [F2.4.1]

Zero — Returns to step [F2]

[F2.4.1 1] Minimum Accept Limit to be Accumulated, after one second displays [XXXXXX]

Press: **Zero** — Enters the entry of minimum acceptable weight which will be accumulated the unit displays [000000], the far left digit flashes. Use **Tare** and **Recall** key to input the minimum accept limit, or key in the value directly from the remote controller.
Then

Press: **Enter** key to confirm, advances to step [F2.4.2 X],

Press: **Zero** key to cancel the input, Returns to step [F2.4].

The unit will not accept the next accumulated value unless the weight value changed by ten digits since the last accumulation.

[F2.4.2 X] Accumulation Mode

Press: **Tare** — Displays next selectable parameters:

0—Disables accumulation (default)

1—Manual accumulation

2—Auto accumulation (only if the weight readings fall below 10 divisions, then return to or above the minimum accept limit and are stable, the next readings can be accumulated.)

Enter — Accepts the selected parameter, enters step [F2.5 X]

Zero — Returns to step [F2.4.1]

[F2.5 X] Weighing Mode

Press: **Tare** — Displays next selectable parameters:

0 — Normal Weighing Mode (default)

1 — Peak hold mode, the instrument displays the detected Maximum weight and holds it, simultaneously the cursor "PEAK" lights. In this mode the accumulation function is not available.

2 — Set Point Mode (Not available without an installed option).

Enter — Accepts the selected parameter, advances to step [F3]

Zero — Returns to step [F2.4]

[F2.6 X] Unit Conversion

Press: **Tare** — Displays next selectable parameters:

0 — no conversion

1 — kg

2 — lb

If the current display unit is kg, select the parameter “2” to convert kilograms into pounds.

If the current display unit is lb, select the parameter “1” to convert pounds into kilograms.

Enter -----Accepts the selected parameter, advances to step [F2.7]

Zero —Returns to step [F2.5]

[F2.7 12] Gravity GEO Adjustment

Press: **Tare** — Displays next parameter, selectable parameters: 0~31

The scale is calibrated with a geo code of 12 at the factory. To adjust the factory calibration to your specific area, refer to the Geo Value Table in the. Enter the new geo code and the calibration will automatically be adjusted for your desired location.

Enter — Accepts the selected parameter, advances to step [F3]

Zero — Returns to step [F2.6]

BATTERY REPLACEMENT



Replacing the battery in the Economy Crane Scale Model XCM (requires 1- 5mm Allen wrench – included in original packaging)

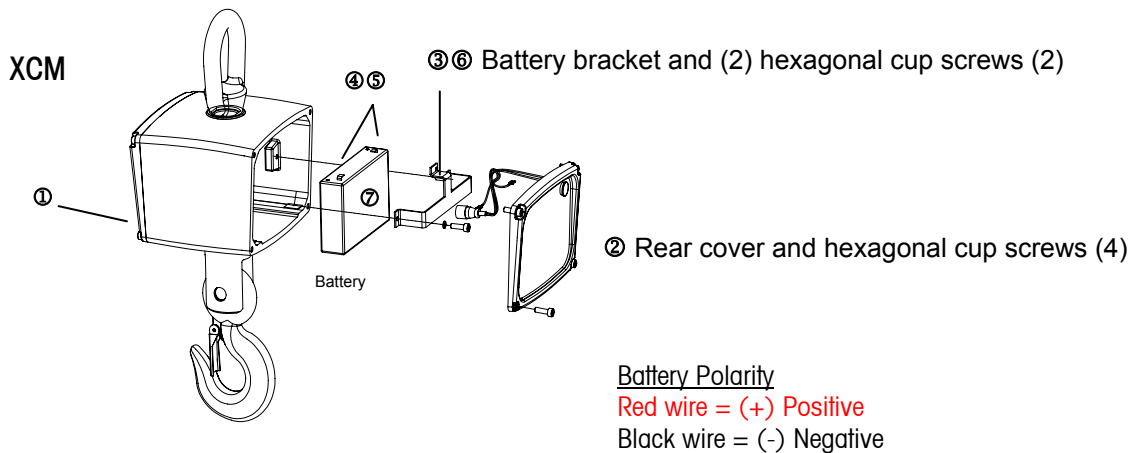

1. Turn the scale off by pressing the on/off pushbutton on the keyboard
2. Remove the rear cover – it is held by four screws
3. Remove the bracket that holds and supports the battery – it is held by two screws
4. Remove the two plastic battery connectors from the pins on the battery
5. Replace and reconnect the battery – please note that the **red wire is (+)** and the black wire is (-) polarity



6. Reassemble the harness, bracket and rear cover
7. Dispose of the "used" (old) battery in according to local laws and regulations

APPENDIX

DEFAULT SETUP PARAMETERS

F1	Scale Interface	Default	F3	Special Function Group	Default
F1.2	Digital filter	2	F3.1	Sleep mode	1
F1.5	Tare operation	1	F3.2	Backlight mode	0
F1.6.2	Auto zero tracing	0	F3.3	Battery selection	0
F1.6.3	Power up zero range	2	F3.4	ID function	0
F1.6.4	Pushbutton zero range	1	F3.6.3	Display alarm mode selection	0
F1.7.1	Motion range	1	F3.7	Memory retention	0
F1.8	Unit selection	0	F3.8	Remote controller function	1
F1.9	Scale capacity	NA			
F1.10	interval	NA			
F1.11	Linearity calibration	0	F4	Serial port Setup	Default
F1.12	Calibration	0	F4.1.1	Output mode selection	0
F1.13	Zero adjustment	0	F4.1.3	Baud rate selection	1200
F1.14	Span adjustment	0	F4.1.4	Data bit and parity bit selection	2
			F4.1.5	Checksum selection	0
			F4.1.6	On-Demand output format selection	1
F2	Environment	Default	F4.1.8	Printers selection	1
F2.4.1	Minimum accept limit	0			
F2.4.2	Accumulation mode	0			
F2.5	Weighing mode	0			
F2.6	Unit conversion	2	F5	Diagnosis	default
F2.7	Gravity adjustment	12	F5.1	Expanded display	0
			F5.2	Scale calibration parameters	0
			F5.3	Display test	0
			F5.4	Keyboard test	0
			F5.5	Serial port test	0
			F5.6	Settings printout	0

 **ERROR MESSAGES**

Error Code	Description	Remedy
E1	EPROM checkout error	1. Power off and back on 2. Replace PCB
E2	Internal RAM checkout error	1. Power off and back on 2. Replace PCB
E3	EEPROM checkout error	1. Power off and back up 2. Replace EEPROM
E35	Calibration test weight is too light	Add additional test weight
E37	The scale is in motion	Re-calibration
Full	Data memory overflow	Clear transaction record
---	Under load indication, under load is below power-on auto zero limit	1. Press Zero empty the scale 2. Check load cell cable connections for looseness
---	Overload indication, overload is nine divisions greater than full capacity	Decrease the load check that the scale has not been damaged
● BAT LOW	Low battery voltage	Charge the battery
L bAt	Low battery voltage, power off automatically in a minute	Charge the battery immediately
SLEEP	Automatically enters the SLEEP mode when the weight isn't obviously changed and the scale isn't in use for five minutes	Press any key on the quick keyboard or the remote controller to activate the scale

SPECIFICATIONS

Capacity: 100 kg/250 lb, 250 kg/500 lb, 500 kg/1000 lb, 1 tonne/2500 lb, 2 tonne/5000 lb

Accuracy class: III

Indication stabilizing time: <10s

Safe overload: 200% F.S.(F.S.---Full Scale)

Ultimate overload: ≥ 500% F.S.

Fatigue life: 1 million times

Tare range: 0 to100% F.S.

Zero range: ± 2% F.S. or 20% F.S.

Operating temperature: -20°C to+50°C

Relative humidity: 10% to 95%, non-condensation.

Storage temperature: -30°C to +60°C

Enclosure protection class: IP65

MAIN SPECIFICATIONS OF LOAD CELLS

Model	TSB (2 and 3 tonnes)	TSA (100,250,500kg,1 tonne)
Input resistance	350±50Ω	2200±50Ω
Output resistance	350±50Ω	2000±50Ω
Load cell sensitivity	2±0.002mv/v	1.5±0.1mv/v
Compensated Temperature Range	-10°C~+40°C	
Excitation Voltage	5±0.5v (DC)	
Safe Overload	200%F.S	
Ultimate Overload	500%F.S	
Enclosure protection Class	IP67	

GEO VALUE TABLE

Use the following geo codes if you relocate the scale to a site other than the original location where it was calibrated.

Northern and Southern latitude in degrees and minutes	Height above sea-level in meters										
	0 325	325 650	650 975	975 1300	1300 1625	1625 1950	1950 2275	2275 2600	2600 2925	2925 3250	3250 3575
	Height above sea-level in feet										
	0 1060	1060 2130	2130 3200	3200 4260	4260 5330	5330 6400	6400 7460	7460 8530	8530 9600	9600 10660	10660 11730
0° 0' — 5° 46'	5	4	4	3	3	2	2	1	1	0	0
5° 46' — 9° 52'	5	5	4	4	3	3	2	2	1	1	0
9° 52' — 12° 44'	6	5	5	4	4	3	3	2	2	1	1
12° 44' — 15° 6'	6	6	5	5	4	4	3	3	2	2	1
15° 6' — 17° 10'	7	6	6	5	5	4	4	3	3	2	2
17° 10' — 19° 2'	7	7	6	6	5	5	4	4	3	3	2
19° 2' — 20° 45'	8	7	7	6	6	5	5	4	4	3	3
20° 45' — 22° 22'	8	8	7	7	6	6	5	5	4	4	3
22° 22' — 23° 54'	9	8	8	7	7	6	6	5	5	4	4
23° 54' — 25° 21'	9	9	8	8	7	7	6	6	5	5	4
25° 21' — 26° 45'	10	9	9	8	8	7	7	6	6	5	5
26° 45' — 28° 6'	10	10	9	9	8	8	7	7	6	6	5
28° 6' — 29° 25'	11	10	10	9	9	8	8	7	7	6	6
29° 25' — 30° 41'	11	11	10	10	9	9	8	8	7	7	6
30° 41' — 31° 56'	12	11	11	10	10	9	9	8	8	7	7
31° 56' — 33° 9'	12	12	11	11	10	10	9	9	8	8	7
33° 9' — 34° 21'	13	12	12	11	11	10	10	9	9	8	8
34° 21' — 35° 31'	13	13	12	12	11	11	10	10	9	9	8
35° 31' — 36° 41'	14	13	13	12	12	11	11	10	10	9	9
36° 41' — 37° 50'	14	14	13	13	12	12	11	11	10	10	9
37° 50' — 38° 58'	15	14	14	13	13	12	12	11	11	10	10
38° 58' — 40° 5'	15	15	14	14	13	13	12	12	11	11	10
40° 5' — 41° 12'	16	15	15	14	14	13	13	12	12	11	11
41° 12' — 42° 19'	16	16	15	15	14	14	13	13	12	12	11
42° 19' — 43° 26'	17	16	16	15	15	14	14	13	13	12	12
43° 26' — 44° 32'	17	17	16	16	15	15	14	14	13	13	12
44° 32' — 45° 38'	18	17	17	16	16	15	15	14	14	13	13
45° 38' — 46° 45'	18	18	17	17	16	16	15	15	14	14	13
46° 45' — 47° 51'	19	18	18	17	17	16	16	15	15	14	14
47° 51' — 48° 58'	19	19	18	18	17	17	16	16	15	15	14
48° 58' — 50° 6'	20	19	19	18	18	17	17	16	16	15	15
50° 6' — 51° 13'	20	20	19	19	18	18	17	17	16	16	15
51° 13' — 52° 22'	21	20	20	19	19	18	18	17	17	16	16
52° 22' — 53° 31'	21	21	20	20	19	19	18	18	17	17	16
53° 31' — 54° 41'	22	21	21	20	20	19	19	18	18	17	17
54° 41' — 55° 52'	22	22	21	21	20	20	19	19	18	18	17
55° 52' — 57° 4'	23	22	22	21	21	20	20	19	19	18	18
57° 4' — 58° 17'	23	23	22	22	21	21	20	20	19	19	18
58° 17' — 59° 32'	24	23	23	22	22	21	21	20	20	19	19
59° 32' — 60° 49'	24	24	23	23	22	22	21	21	20	20	19
60° 49' — 62° 9'	25	24	24	23	23	22	22	21	21	20	20
62° 9' — 63° 30'	25	25	24	24	23	23	22	22	21	21	20
63° 30' — 64° 55'	26	25	25	24	24	23	23	22	22	21	21
64° 55' — 66° 24'	26	26	25	25	24	24	23	23	22	22	21
66° 24' — 67° 57'	27	26	26	25	25	24	24	23	23	22	22
67° 57' — 69° 35'	27	27	26	26	25	25	24	24	23	23	22
69° 35' — 71° 21'	28	27	27	26	26	25	25	24	24	23	23
71° 21' — 73° 16'	28	28	27	27	26	26	25	25	24	24	23
73° 16' — 75° 24'	29	28	28	27	27	26	26	25	25	24	24
75° 24' — 77° 52'	29	29	28	28	27	27	26	26	25	25	24
77° 52' — 80° 56'	30	29	29	28	28	27	27	26	26	25	25
80° 56' — 85° 45'	30	30	29	29	28	28	27	27	26	26	25
85° 45' — 90° 00'	31	30	30	29	29	28	28	27	27	26	26

PHYSICAL DIMENSIONS

Model	Capacity [lb]	Resolution [lb]	Dimensions ["]						Shipping Information			
			H	D	φ1	F	φ2	φ3	L ["]	W ["]	H ["]	WT [lb]
XC01M-00	250	0.1	14.9	1	1.2	2.4	1.8	0.6	16.9	10.2	11.4	33.0
XC02M-00	500	0.2							16.9	10.2	11.4	33.0
XC03M-00	1000	0.5							16.9	10.2	11.4	33.0
XC04M-00	2500	1							16.9	10.2	11.4	33.0
XC10M-00	5000	2	17.4	1.1	1.2			16.9	10.2	11.4	33.0	

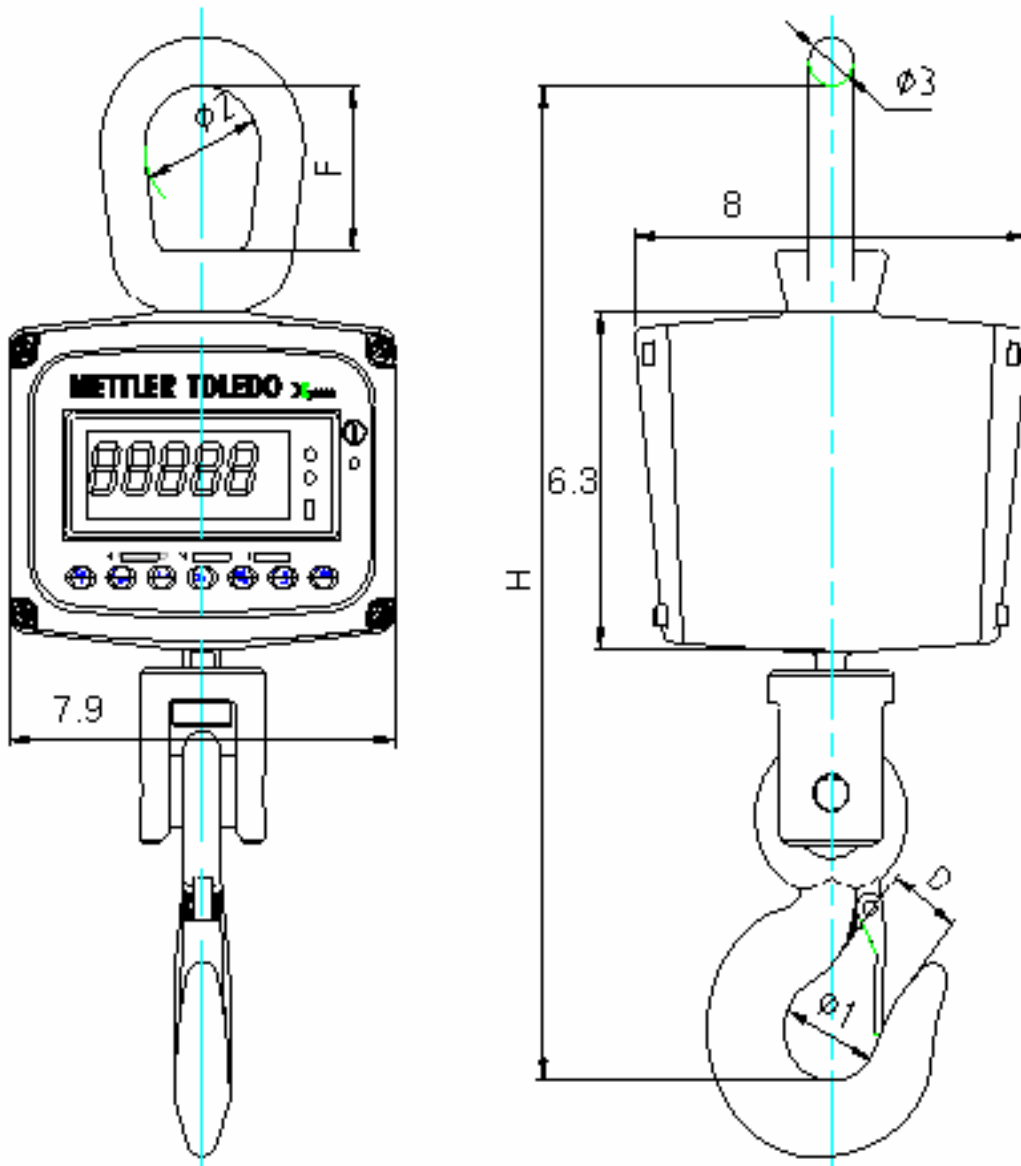

Notes

Xpress

Mettler-Toledo, Inc.
60 Collegeview
Westerville, OH 43081

5/2004
MTC04-OM027.1E